



Investigating fuel consumption of refuse truck vehicles by presenting hybrid and fully electric structures

Reza Sabet¹, Mohsen Esfahanian^{2*}, Mohammad Reza Forouzan³

¹Reza Sabet, Master student, Department of Mechanical Engineering, Isfahan University of Technology.

²Mohsen Esfahanian, Associate Professor, Department of Mechanical Engineering, Isfahan University of Technology.

³Mohammad Reza Forouzan, Professor, Department of Mechanical Engineering, Isfahan University of Technology.

ARTICLE INFO

Article history:

Received : 5 Feb 2025

Accepted: 16 Aug 2025

Published: 7 Sep 2025

Keywords:

Refuse truck
hydraulic hybrid
fully electric
hybrid
fuel consumption

ABSTRACT

Conventional diesel engine, hydraulic hybrid, and fully electric powertrain structures were modeled to assess fuel consumption in a sample urban refuse collection truck. The components utilized in the modeling include an internal combustion engine, transmission, electric motor, and battery. To this end, the vehicle's driving cycle is initially analyzed and characterized. The target vehicle is a light duty N series Isuzu 8 tones truck. Based on the simulations conducted in the MATLAB/Simulink environment, the hydraulic hybrid configuration demonstrated the lowest fuel consumption for the Refuse truck vehicle, achieving 27.6 liters of diesel fuel per 100 kilometers. The fully electric configuration exhibited a fuel consumption value closely approaching that of the hydraulic hybrid. Eventually, based on the obtained results, the layout of the equipment for the finalized configurations was designed in the Autodesk Inventor software environment.

1. Introduction

With the rapid economic growth and infrastructure development driven by urbanization and motorization in developing countries, the demand for fossil fuel-based transportation is increasing swiftly. This surge contributes to greenhouse gas emissions and urban air pollution, adversely affecting residents' health and diminishing overall urban well-being. Consequently, identifying efficient solutions to mitigate greenhouse gas emissions is of

paramount importance. One such solution is the adoption of hybrid vehicles in both urban and non-urban environments. A hybrid vehicle utilizes two or more power sources for propulsion, typically combining a diesel or gasoline internal combustion engine with a secondary electric or hydraulic power source. Air pollution poses both environmental and societal challenges, generating numerous adverse effects on human health, ecosystems, and climate. Air quality in urban areas is a critical factor directly influencing the incidence of diseases [1]. To

*Corresponding Author
Email Address: mesf1964@iut.ac.ir
<https://doi.org/10.22068/ase.2025.713>

reduce fossil fuel consumption and carbon dioxide emissions, it is imperative to replace conventional propulsion systems with advanced alternatives. The use of hybrid vehicles represents a viable strategy to address this issue [2]. Research indicates that hybrid powertrains can significantly reduce fuel consumption in urban vehicles [3]. refuse trucks, due to their specific operational requirements, necessitate propulsion systems that outperform conventional diesel trucks. The use of diesel trucks in this fleet often faces challenges, as their internal combustion engines frequently operate in low-efficiency regimes. Moreover, a substantial portion of the energy generated by the engine is dissipated through frictional braking during deceleration. In recent years, significant advancements have been made in technologies aimed at reducing energy consumption and emissions. These include alternative fuels such as compressed natural gas (CNG), hydraulic or electric regenerative braking systems, hybrid hydraulic and electric powertrains, and fully electric trucks. These solutions not only enhance fleet efficiency but also mitigate environmental impacts. Key parameters, such as driving cycles and the loading cycles of auxiliary hydraulic systems, play a critical role in evaluating and optimizing hybrid or fully electric powertrains. These parameters are essential for predicting and analyzing fuel consumption, emission levels, and vehicle performance during the design, simulation, and testing phases. The derivation of driving cycles is influenced by multiple factors, including vehicle type and application, traffic conditions, weather, data collection timing, and driver behavior, all of which can significantly affect the outcomes. Thorough analysis of these variables can enhance the accuracy of hybrid system design and optimization.

The operational cycle of refuse trucks comprises repetitive phases, including acceleration,

constant-speed cruising, braking, and stopping. During each cycle, a considerable amount of the truck's kinetic energy is dissipated through frictional braking. This energy loss substantially impacts fuel consumption and overall system efficiency.

During stops, municipal waste is mechanically loaded into the truck's receptacle. The power required for this process is supplied by an auxiliary hydraulic system, with its pump connected to the internal combustion engine via the power take-off (PTO) shaft. To enhance the performance of mechanized systems during this phase, the driver increases engine speed to deliver greater power to the PTO and, consequently, the hydraulic pump. This process typically leverages optimized mechanized designs to maximize operational efficiency. However, advanced methods, such as kinetic energy recovery and the integration of modern technologies, can further reduce energy losses and improve system efficiency.

1.1 Hydraulic Hybrid

Filippi et al. [4] proposed a hydraulic hybrid powertrain for a heavy-duty vehicle to reduce fuel consumption and emissions. In their proposed configuration, the internal combustion engine is not directly connected to the wheels; instead, power transmission to the wheels is facilitated through a hydraulic pump, realizing a series hydraulic hybrid structure. To optimize fuel consumption, the internal combustion engine operates in its most efficient regime, controlled by a thermostatic controller. Through modeling and simulation, they observed a remarkable 72% reduction in fuel consumption. Similarly, Zou et al. [5] introduced a series hydraulic hybrid powertrain for a passenger vehicle operating under the Urban Dynamometer Driving Schedule (UDDS). The key advantage of their configuration lies in the internal combustion engine functioning within its optimal efficiency

range, leading to reduced fuel consumption. Compared to a conventional vehicle and validated through experimental results, they achieved a fuel consumption reduction of 35.59%. Barbosa et al. [6] developed a hydraulic hybrid system to reduce fuel consumption in a vehicle weighing 1100 kg. By deriving the driving cycle of the target vehicle and validating their model, they reported a 37% reduction in fuel consumption compared to the conventional configuration. Kim and Rousseau compared electric and hydraulic hybrid systems for a truck across various driving cycles. Their findings indicated that in aggressive driving conditions, the electric hybrid exhibited superior performance and fuel consumption reduction compared to the hydraulic hybrid. However, in non-aggressive driving scenarios, such as urban environments, the hydraulic hybrid outperformed the electric hybrid. This is primarily due to the significant energy recovery during braking in urban driving cycles, which enhances the efficiency of hydraulic hybrid systems through repeated regenerative braking. Additionally, they demonstrated that parallel configurations, for both electric and hydraulic hybrids, generally outperform series configurations [7]. Makour and Rosti investigated the performance of tractors and loaders with a proposed hydraulic hybrid system, determining optimal operating conditions for these off-road vehicles [8]. In a study by Makour et al. [9] on urban buses, the average efficiency of a vehicle equipped with a hydraulic hybrid system was found to be 95%, compared to 77% for a conventional counterpart. Furthermore, the regenerative efficiency, defined as the ratio of energy supplied to the vehicle to the kinetic energy available during braking, was approximately 40%. This efficiency could be further improved by optimizing the volume and operating pressure of the hydraulic accumulator.

1.2 Electric Hybrid

Lin et al. [10] proposed an electric hybrid powertrain to reduce fuel consumption in a heavy-duty vehicle. They employed dynamic programming (DP) to optimize power management for a hybrid electric truck, aiming to identify the most effective strategy for a specific driving cycle by minimizing a defined cost function. Two scenarios were evaluated: one focused solely on fuel consumption and another balancing fuel efficiency with greenhouse gas emissions. The comparison elucidated the adjustments required when emission reduction is prioritized. The proposed strategy yielded improvements ranging from 50% to 70%. Rapp et al. [11] conducted a comparative analysis of emissions between conventional and electric hybrid vehicles. Their results indicated that, over its lifetime, a hybrid vehicle emits 4.34 g CO₂ per ton-kilometer less than a diesel truck. This analysis underscores the benefits of electric powertrains, with emissions offset after approximately 15,800 km (roughly 1.5 months of operation). The break-even point, in terms of distance and CO₂, is significantly influenced by fuel type, battery production emissions, and driving conditions, with variations in these parameters extending the break-even distance.

Lin et al. [12] compared fuel consumption between conventional and electric hybrid vehicles, employing a control strategy to minimize fuel use. Their model-based approach utilized dynamic programming to identify optimal control actions for maximizing fuel efficiency. A near-optimal control strategy was developed and implemented using a rapid control prototyping system, enabling flexible algorithm tuning and accommodating various input/output configurations. Testing on a dynamometer demonstrated that the proposed algorithm enabled the hybrid truck prototype to achieve a 45% improvement in fuel efficiency compared to its non-hybrid counterpart, outperforming a

traditional rule-based control method, which yielded only a 31% improvement in the same hybrid vehicle.

Lejonin [13] examined fuel consumption differences between conventional and hybrid heavy-duty vehicles. Four heavy vehicle configurations with varying weights and three parallel hybrid systems designed for heavy-duty propulsion were analyzed. Simulation models for both conventional diesel and parallel hybrid configurations were developed using the Autonomie software and tested on real-world routes typical of trucks in southern Finland. Results showed that for each additional ton of total vehicle weight, fuel consumption increased by 0.65 to 0.95 liters per 100 km, depending on the route. Specific fuel consumption per payload weight (fuel per ton-kilometer) decreased by an average of 17% as gross weight increased from 40 to 60 tons, 23% from 40 to 76 tons, and 28% from 40 to 90 tons. Hybridization was found to improve combined fuel consumption by up to 6%, with greater benefits observed on routes involving more uphill driving.

Purolator, a Canadian courier company, recently integrated hybrid electric vehicles (HEVs) into its fleet. Bachman et al. [14] assessed the fuel savings and greenhouse gas (GHG) reductions of Purolator's hybrid trucks using GHGenius, a model developed by the Canadian government. Their findings indicated that Purolator's diesel hybrid trucks reduced GHG emissions by up to 23% in urban driving and 8% on highways, aligning with the manufacturer's claim of up to 25% CO₂ reduction with HEV fleets. However, the lifecycle costs of hybrid delivery trucks currently render them less financially competitive than traditional diesel trucks, with competitiveness varying based on factors such as truck lifespan, diesel fuel prices, assumed discount rates, and additional costs associated with hybrid technology.

Zhou et al. [15] investigated technologies to enhance powertrain efficiency and performance for fuel consumption reduction in heavy-duty trucks. Their results demonstrated that improving engine efficiency, reducing aerodynamic drag, and minimizing rolling resistance could reduce fuel consumption by 6% to 13% for daily and highway driving cycles. Hybrid technologies were found to achieve up to 16% fuel savings, proving economically viable for daily operations. Kwasi-Effah and Obanor [16] presented a model of a 1325-kg series-parallel gasoline-electric vehicle (GEV) with a maximum power output of 57 kW from the internal combustion engine (ICE) and 50 kW from the electric motor. Modeling and simulation conducted in MATLAB/Simulink demonstrated a cost-effective tool for designing gasoline-electric vehicles, facilitating component optimization.

1.3 Fully Electric

Kiyakli and Solmaz [17] modeled a fully electric vehicle to calculate the energy required to complete a driving cycle, using MATLAB and Simulink. They investigated how various parameters affect vehicle performance and energy consumption. The modeling results indicated that the electric vehicle consumes 15.82 kWh per 100 km and achieves a range of 177 km according to the New European Driving Cycle (NEDC), introduced in 1997. Additionally, the vehicle was tested using the Worldwide Harmonized Light Vehicles Test Procedure (WLTP), which showed an energy consumption of 17.93 kWh per 100 km and a range of 157 km. Regenerative braking contributed to an 8% energy saving over 100 km.

Sharmila et al. [18] developed a simplified electric vehicle model using Simscape components in MATLAB. This dynamic model incorporated a drive cycle source, battery, driver controller, power converter, motor, and vehicle subsystem. Vasam et al. [19] analyzed the impact

of road gradient on the dynamic performance of a three-wheeled solar electric vehicle. In India, three-wheeled electric vehicles are a key mode of public transportation in congested areas. Road gradient significantly affects vehicle performance, and their study provided a detailed analysis of its impact on the dynamic performance of a three-wheeled solar electric vehicle. A physical model was created using the Simscape environment. Aduohan et al. [20] proposed a methodology for designing and developing electric vehicle (EV) powertrains through modeling, simulation, and real-world validation. While software simulation of EV powertrains is critical in the design process, validating these models against real vehicle systems is equally essential for enhancing reliability, safety, and performance. Their approach utilized MATLAB/Simulink for powertrain modeling and simulation, with results validated on a real vehicle tested on a chassis dynamometer.

The objective of this study is to identify the optimal powertrain configuration for minimizing fuel consumption in the relevant driving cycle. To achieve this, forward modeling will be employed, where the driving cycle is defined, and the driver uses accelerator and brake pedals to generate signals for other components (gearbox, throttle, clutch). These signals are processed in sequential steps, with feedback used to refine commands. In contrast, backward modeling feeds the driving cycle speed into the model, determining powertrain components based on this input. Initially, the municipal waste collection vehicle is modeled in its conventional form, powered by a diesel engine. Subsequently, hydraulic hybrid and fully electric configurations are modeled, followed by the layout of components in Autodesk Inventor.

In many studies on driving cycle derivation, only vehicle speed variations over time are typically considered, assuming constant vehicle weight

and zero road gradient. For instance, the first driving cycle for municipal waste collection trucks, named "NYGTC1," was developed in 1995 by West Virginia University in New York City. The data for this cycle, as shown in Figure 1, were collected from the daily operation of a refuse truck.

The NYGTC1 driving cycle not only provides valuable insights into the movement patterns of municipal waste collection trucks but also serves as a foundation for enhancing efficiency and reducing energy consumption in the design and development of these vehicles. This cycle includes nine stops, three of which are dedicated to waste collection operations. As depicted in Figure 2, the vehicle is engaged in urban service tasks for 75% of the cycle, with the remaining 25% allocated to transit. These characteristics are specifically designed to enable precise evaluation of fuel consumption and pollutant emissions by waste collection trucks. Given that these trucks typically operate at low average speeds with frequent stops, analysis of this cycle yields critical information regarding their environmental performance and energy efficiency.

Pakdel et al. [22] derived the driving cycle for a refuse truck vehicle in Tehran, as presented in Figure 3. According to their analysis, the vehicle is stationary and engaged in service-related tasks for approximately 47% of the driving cycle. Additionally, 19% of the cycle is spent accelerating, 16% involves cruising at a constant speed, and 18% is dedicated to braking. This functional breakdown is further illustrated in Figure 4.

In the continuation of the study, the driving cycle described (as derived by Pakdel et al. [22] for the refuse truck vehicle in Tehran) will be used as the reference for modeling.

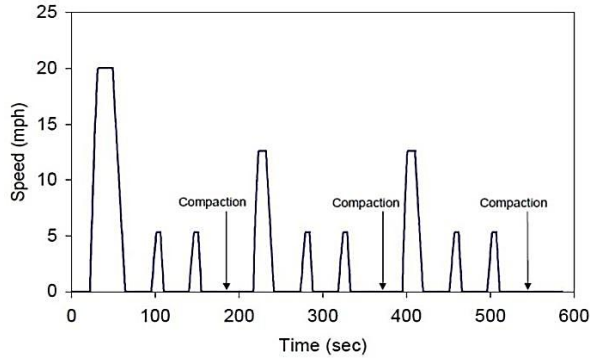

Figure 1: Driving Cycle of the refuse truck Vehicle [21].

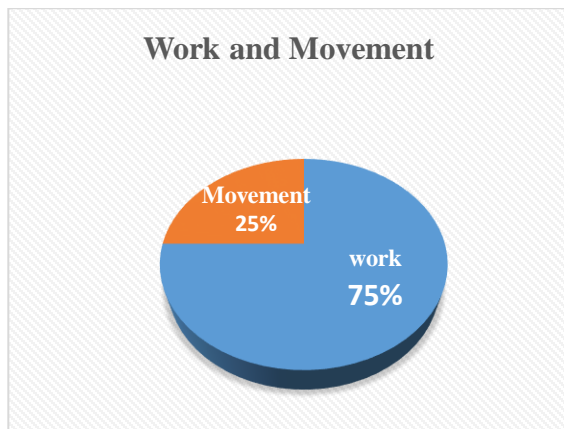

Figure 2: Chart of Work and Movement of the refuse truck vehicle.

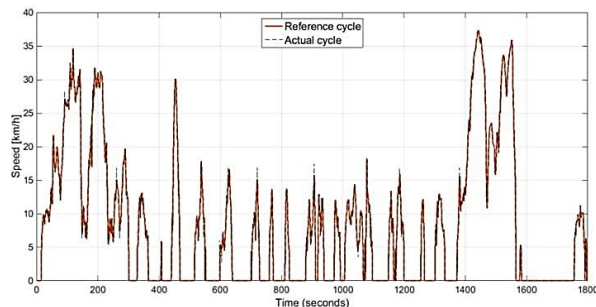

Figure 3: Driving Cycle of the refuse truck vehicle in Tehran [22].

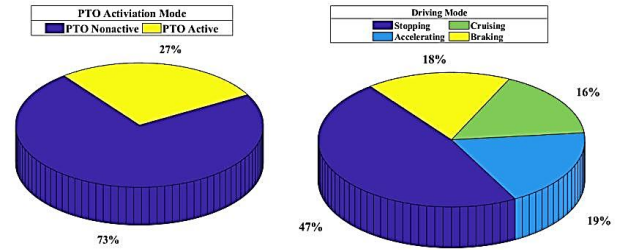

Figure 4: Breakdown of the Driving Cycle of the refuse truck vehicle Vehicle [22]

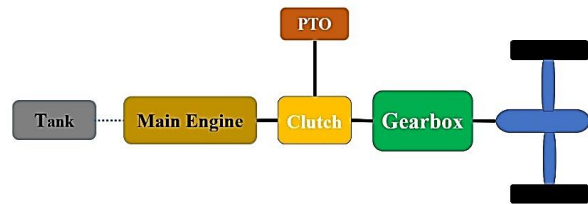

Figure 5: Conventional Structure of the refuse truck vehicle block diagram.

2. Structure and Modeling

2.1 Conventional Structure

The structure considered for the refuse truck vehicle is depicted in Figure 5. This structure is initially modeled as a forward model in the Simulink environment.

The developed model in the Simulink environment, as shown in Figure 6, consists of driver, gearbox, internal combustion engine, and vehicle dynamics blocks.

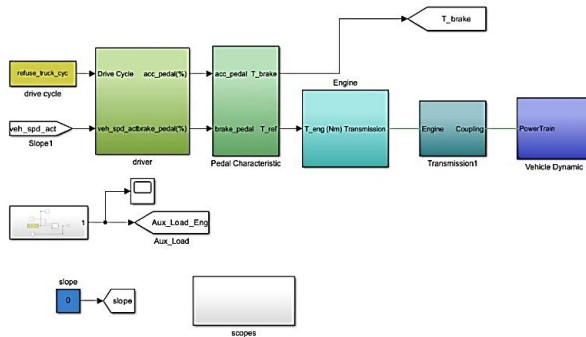

Figure 6: Modeling the conventional structure of a refuse truck vehicle block diagram.

2.1.1 Driver Block

This block is used to follow the driving cycle and, in effect, traverse the path at the desired input speed. The block operates by generating a final command signal proportional to the input error. Specifically, the input is the error signal, and the output of the block is the command signal, which corresponds to motor torque and braking (these are the block's outputs).

Additionally, this block employs a stateflow chart to determine the driving mode used for gear shifting. The stateflow chart, based on predefined driving modes and the input driving cycle, determines the neutral (idle) and drive states. This is illustrated in Figure 7.

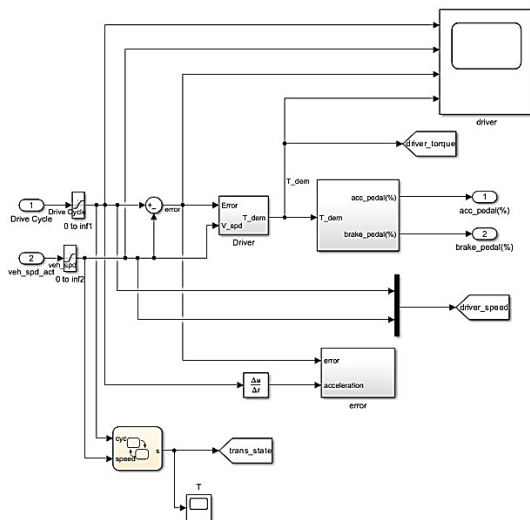

Figure 7: Driver block structure.

2.1.2 The internal combustion engine (ICE) block

as illustrated in Figure 8, performs three main functions: idle speed control, engine torque determination, and fuel consumption calculation. The idle speed control sub-block calculates the required engine torque to achieve a specified target RPM. The torque determination sub-block processes three inputs - idle torque, engine drag torque, and driver-commanded torque - and uses interpolation from the engine's torque curve to determine the available output torque. Finally, the fuel consumption sub-block computes the fuel usage rates for both driving and idle operating conditions, completing the comprehensive engine modeling system. The specifications of the modeled internal combustion engine (ICE) along with required constants are presented in Table 1.

2.1.1 Gearbox Block

This block, as illustrated in Figure 9, consists of three main components: the clutch block, gear shifting block, and engine-to-vehicle dynamics linkage block. The clutch block receives inputs including driving mode, reference speed, and actual vehicle speed to determine the clutch engagement state. The gear shifting block utilizes a stateflow chart to determine the optimal gear shift timing based on the vehicle's current speed. Finally, the engine-to-vehicle dynamics linkage block connects the engine's output torque to the vehicle's drivetrain system, completing the powertrain control architecture.

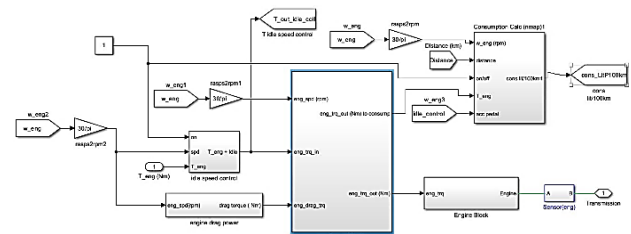

Figure 8: Internal Combustion Engine (ICE) Block Diagram.

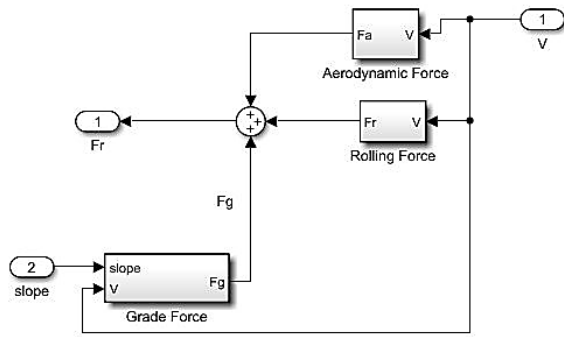

Figure 11: Vehicle Resistance Forces Model block diagram.

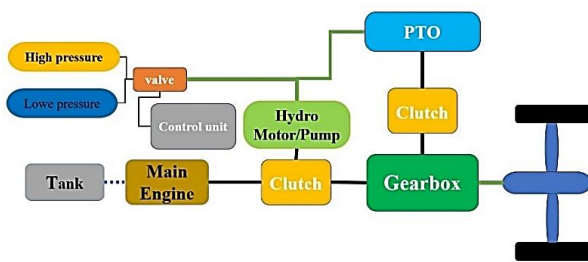

Figure 12: Hydraulic hybrid structure of the standard refuse truck vehicle block diagram.

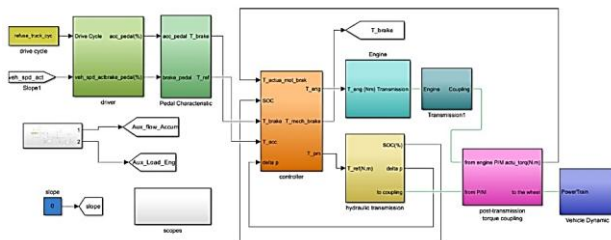

Figure 13: Modeling of the hydraulic hybrid system structure of the refuse truck vehicle block diagram.

2.2 Hydraulic Hybrid

In this structure, as mentioned, a hydraulic hybrid auxiliary system was utilized to perform service tasks. The setup is such that if the hydraulic hybrid auxiliary system is charged to a certain level, it is used for service tasks. Otherwise, the internal combustion engine is employed to carry out these tasks. This configuration can be seen in Figure 12.

Finally, this structure was modeled as shown in Figure 13. In this modeling, the hydraulic hybrid components discussed in previous sections were utilized.

2.3 Fully Electric structure

The fully electric architecture of the refuse truck vehicle is illustrated in Figure 14. Furthermore, the system was modeled in Simulink environment as shown in Figure 15.

The implemented structure includes the following modeled components: electric motor, vehicle dynamics, driving cycle, battery system, current distributor, output interfaces, and auxiliary loads. For this model, an 85 kW electric motor was used, with specifications provided in Table 3 and motor configuration shown in Figure 16.

Table 3: Specifications of the electric motor.

Rated power (kw)	85
Rated torque (Nm)	220
Max torque (Nm)	530
Max speed (rpm)	10000

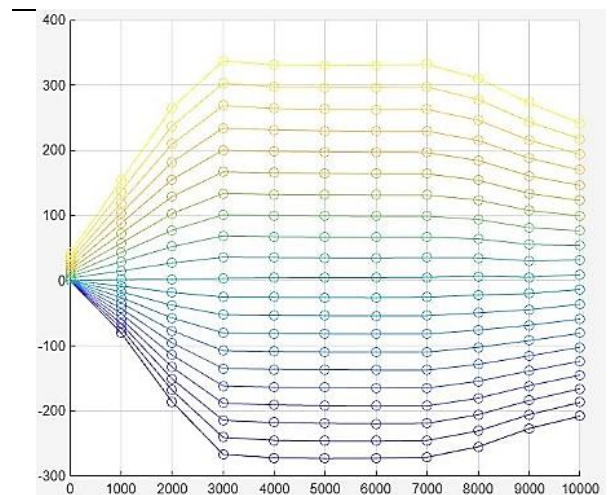

Figure 16- Schematic diagram of the electric motor.

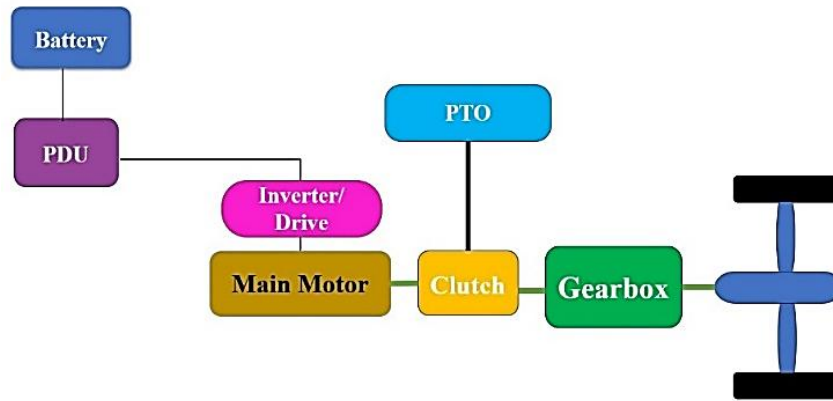

Figure 14: Full-electric configuration of the refuse truck vehicle block diagram.

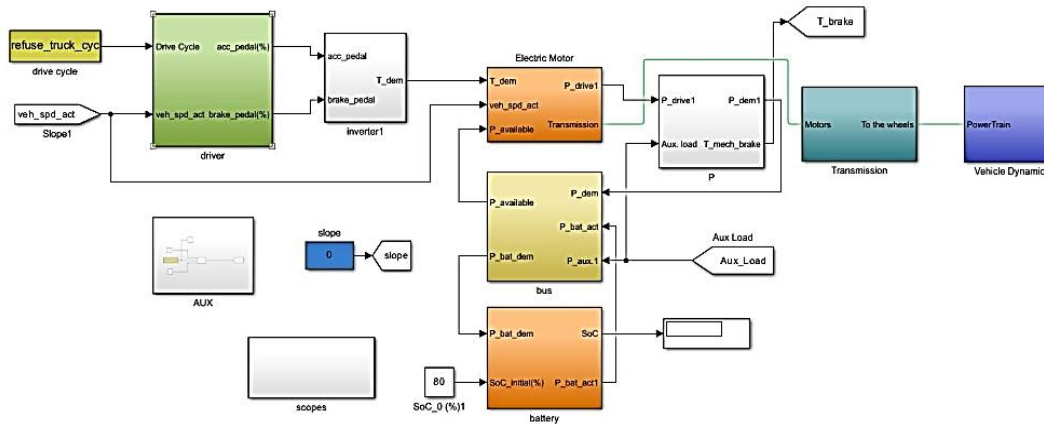

Figure 15: Modeling of the Full-electric configuration system structure of the refuse truck vehicle block diagram.

3. Result and discussion

3.1 Modeling Results of Conventional refuse truck vehicle

The simulation results of the conventional refuse truck vehicle model (Figure 17-a) demonstrated a fuel consumption of 1.4 liters during the driving cycle, with fuel economy measurements of 32.42 liters per 100 kilometers and 12.76 liters during idling operation (Figure 17-b), while Figure 27-c illustrates the performance characteristics of the auxiliary system.

3.2 Modeling Results of Hydraulic Hybrid refuse truck vehicle

The simulation of the hydraulic hybrid refuse truck vehicle after completing the driving cycle (Figure 18-a) showed fuel consumption of 5.8 liters during idling operation and 27.6 liters per 100 kilometers during driving (Figure 18-b). Additionally, Figures 18-c and 18-d demonstrate the operational strategy of the service system for utilizing dual power sources.

Investigating fuel consumption of refuse truck vehicles by presenting hybrid and fully electric structures

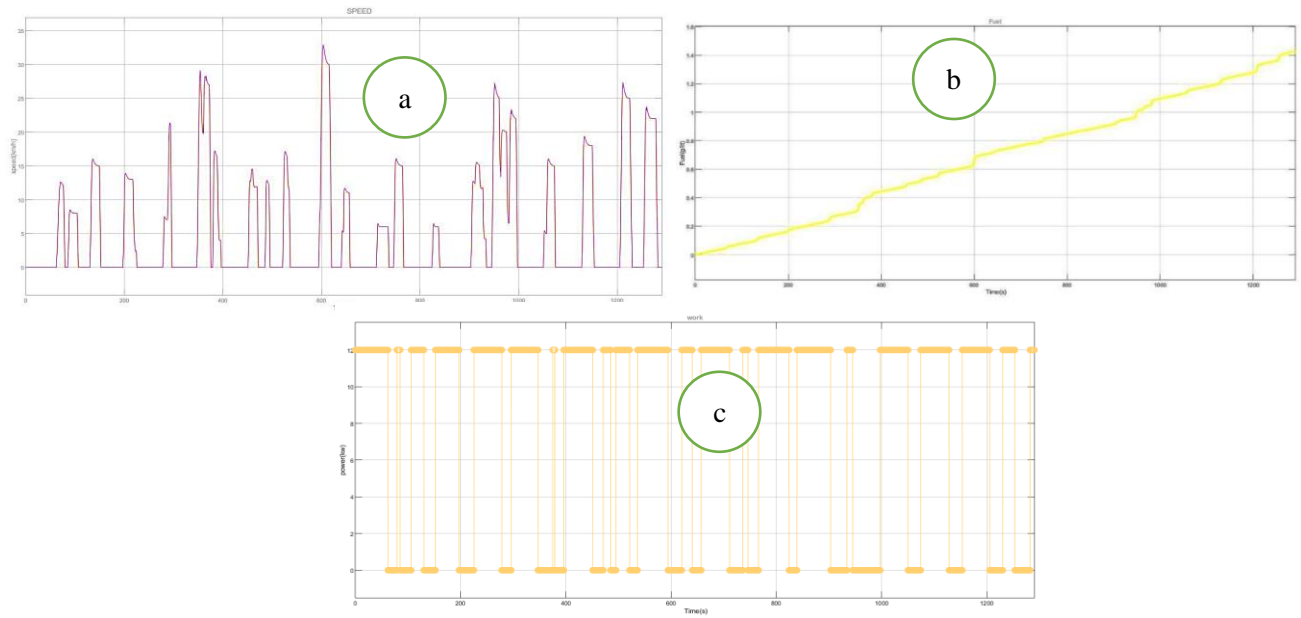

Figure 17: result of the Conventional refuse truck vehicle: a. driving cycle, b. fuel consumption , c. power of the auxiliary system.

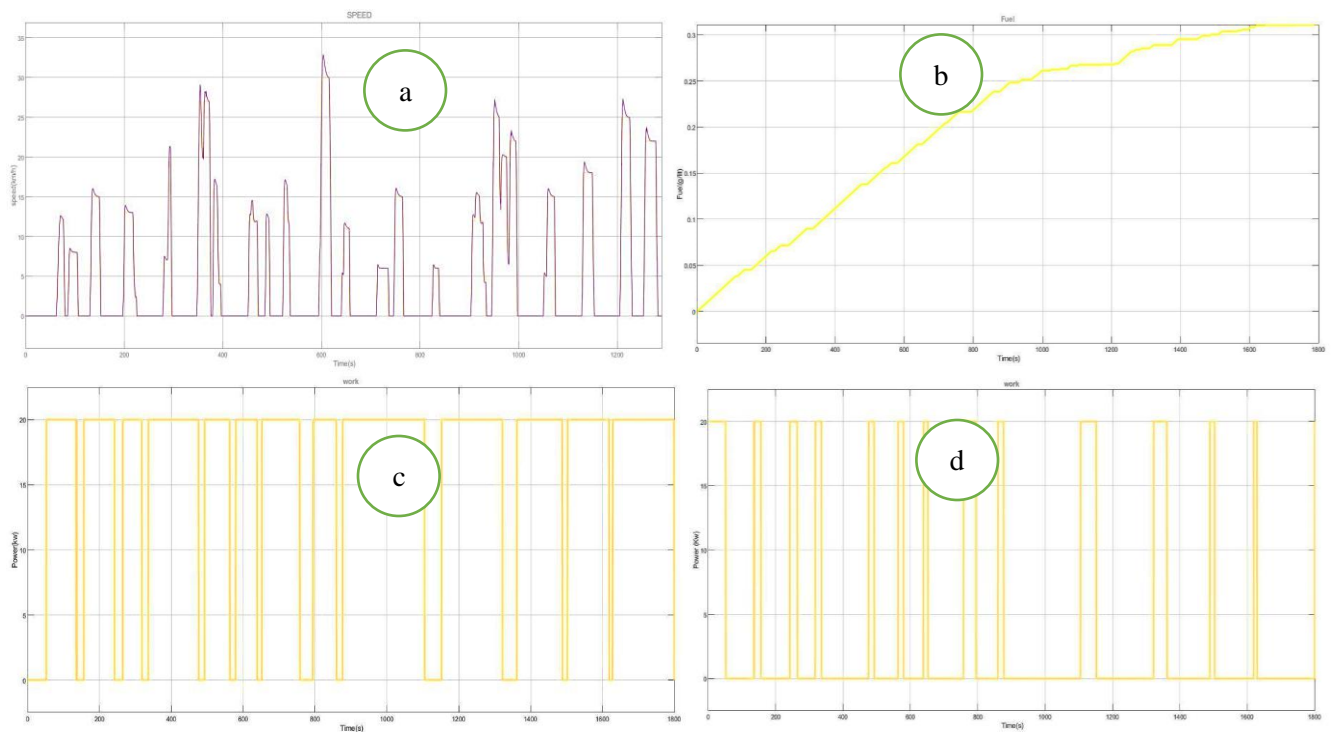

Figure 18: result of the hydraulic hybrid refuse truck vehicle: a. driving cycle, b. fuel consumption , c. power of the auxiliary system, d. power of the auxiliary system.

3.3 The modeling results of the fully electric refuse truck vehicle structure

as illustrated in Figure 19, indicate that after completing the driving cycle, state of charge (SoC), based on the specifications outlined in previous stages, reached 55%, as shown in Figure 35, while the battery power demand was observed to be 25 kilowatt-hours.

For better compare the structures, it is advisable to examine the fuel consumption of power plants for electricity generation. According to the latest published version of the Energy Balance Sheet, the average efficiency of the country of Iran thermal power plants in 2022 was 39.1%. Accordingly, considering the calorific value of diesel as 10.5, approximately 0.24 liters of diesel is consumed to produce 1 kilowatt-hour of electrical energy. The urban waste collection vehicle, based on modeling results, exhibited a fuel consumption of 32.42 liters per 100 kilometers in normal operation and 12.73 liters in idling mode for the conventional structure. In contrast, the hydraulic hybrid structure showed a

fuel consumption of 27.6 liters per 100 kilometers and 5.89 liters in idling mode, indicating a fuel consumption reduction of approximately 17.59% in driving mode and 53.73% in idling mode compared to the conventional structure. Furthermore, the fully electric waste collection vehicle structure demonstrated a battery power demand of 125 kilowatt-hours for a 100-kilometer journey. Consequently, to generate approximately 125 kilowatt-hours of energy required for the waste collection vehicle to travel 100 kilometers, about 30 liters of diesel would need to be consumed in a power plant with an efficiency of 39.1%. The comparison of fuel consumption across these structures is illustrated in Figure 20.

Based on the comparison conducted, the fuel consumption of the hydraulic hybrid structure is lower than that of both the fully electric and conventional structures. The layout of the equipment for the conventional structure (Figure 21-a), hydraulic hybrid structure (Figure 21-b) and fully electric structure (Figure 21-c) of the refuse truck vehicle is shown in Figure 21.

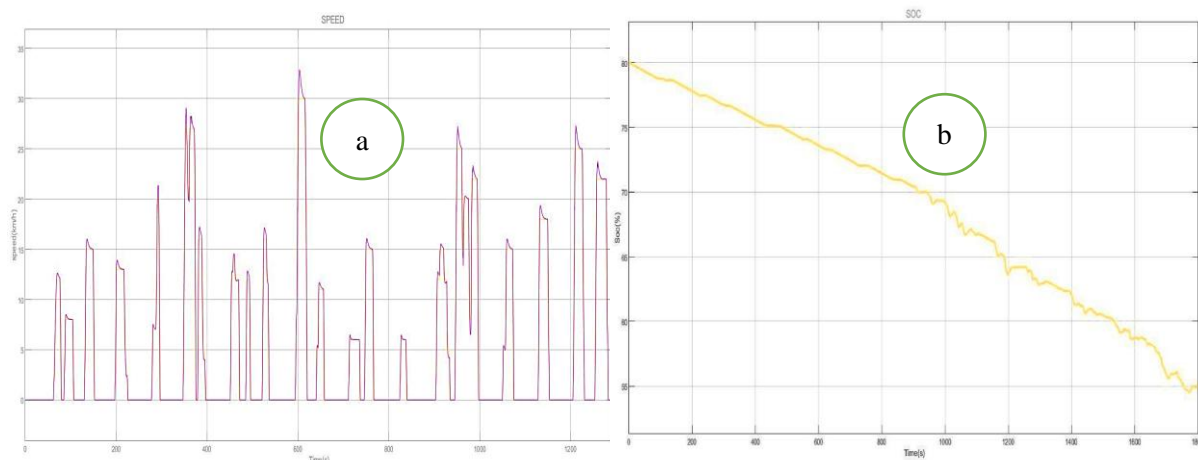

Figure 19: result of the hydraulic hybrid refuse truck vehicle: a. driving cycle, b. state of charge.

Investigating fuel consumption of refuse truck vehicles by presenting hybrid and fully electric structures

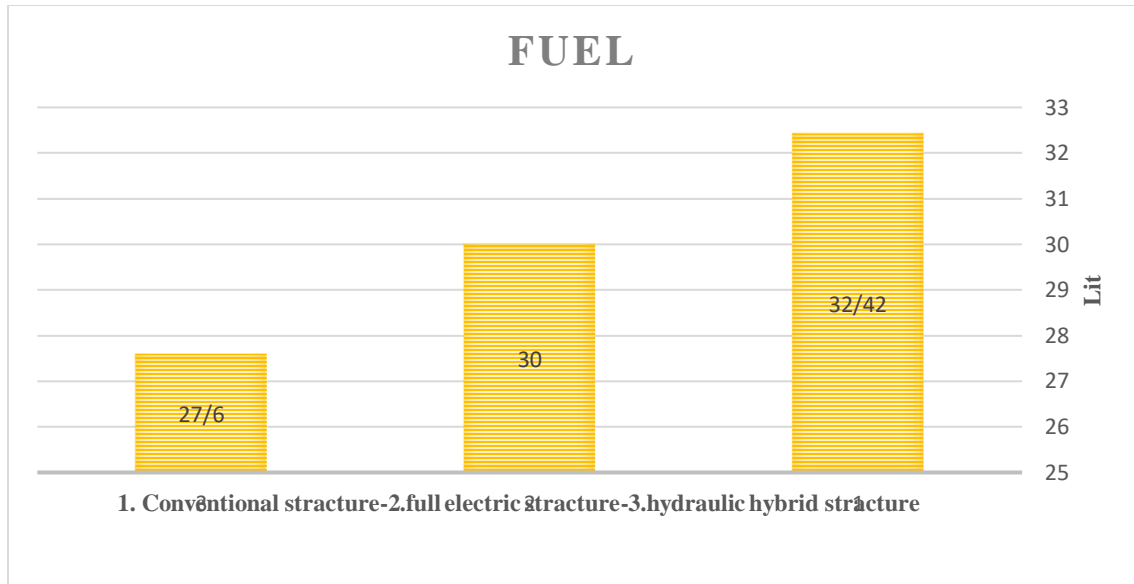

Figure 20 : Comparison of fuel consumption of structures

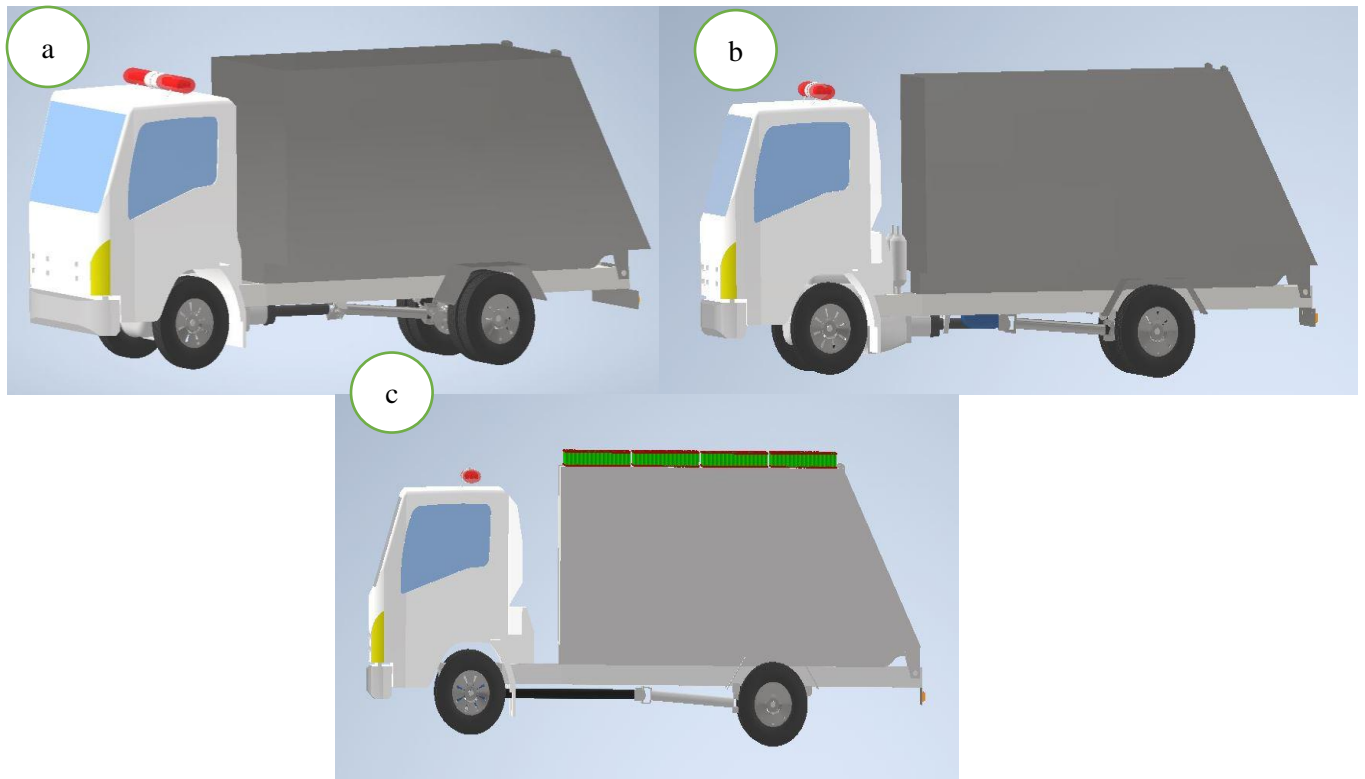

Figure 21 : Equipment placement : a. conventional, b. hydraulic hybrid, c. fully electric.

Conclusion

The objective of the conducted research was to investigate and evaluate the feasibility of implementing new powertrain systems for a refuse truck vehicle. Through a review of existing studies, the target vehicle was identified, and the parameters affecting its fuel consumption were determined. Based on the gathered information, several structures were proposed to reduce fuel consumption. The proposed structures were modeled using MATLAB/Simulink software, and all configurations were analyzed and simulated. The results indicated that the hydraulic hybrid structure was the most fuel-efficient for the refuse truck vehicle. However, the difference in fuel consumption between the hydraulic hybrid and fully electric structures was minimal, suggesting that the optimal structure may depend on the specific driving cycle of the city in question. Finally, Autodesk Inventor software was utilized for the equipment layout design, and all proposed structures were implemented for the vehicle.

References

- [1] M. B. Marinov, I. Topalov, E. Gieva, and G. Nikolov, "Air quality monitoring in urban environments," in *2016 39th International Spring Seminar on Electronics Technology (ISSE)*, 2016: IEEE, pp. 443-448.
- [2] L. Guzzella and A. Sciarretta, *Vehicle propulsion systems*. Springer, 2007.
- [3] A. Ritari, J. Vepsäläinen, K. Kivekäs, K. Tammi, and H. Laitinen, "Energy consumption and lifecycle cost analysis of electric city buses with multispeed gearboxes," *Energies*, vol. 13, no. 8, p. 2117, 2020.
- [4] Z. Filipi and Y. Kim, "Hydraulic hybrid propulsion for heavy vehicles: combining the simulation and engine-in-the-loop techniques to maximize the fuel economy and emission benefits," *Oil & Gas Science and Technology—Revue de l'Institut Français du Pétrole*, vol. 65, no. 1, pp. 155-178, 2010.
- [5] H. Zhou, Z. Xu, L. Liu, D. Liu, and L. Zhang, "Design and validation of a novel hydraulic hybrid vehicle with wheel motors," *Science progress*, vol. 103, no. 1, p. 0036850419878024, 2020.
- [6] T. P. Barbosa, L. A. R. da Silva, F. J. P. Pujatti, and J. C. H. Gutiérrez, "Hydraulic hybrid passenger vehicle: Fuel savings possibilities," *Mechanics Based Design of Structures and Machines*, vol. 50, no. 1, pp. 135-153, 2022.
- [7] N. Kim and A. Rousseau, "A comparative study of hydraulic hybrid systems for class 6 trucks," SAE Technical Paper, 0148-7191, 2013.
- [8] A. Macor and A. Rossetti, "Optimization of hydro-mechanical power split transmissions," *Mechanism and machine theory*, vol. 46, no. 12, pp. 1901-1919, 2011.
- [9] A. Macor, A. Benato, A. Rossetti, and Z. Bettio, "Study and simulation of a hydraulic hybrid powertrain," *Energy Procedia*, vol. 126, pp. 1131-1138, 2017.
- [10] C.-C. Lin, H. Peng, J. W. Grizzle, and J.-M. Kang, "Power management strategy for a parallel hybrid electric truck," *IEEE transactions on control systems technology*, vol. 11, no. 6, pp. 839-849, 2003.
- [11] M. Rupp, S. Schulze, and I. Kuperjans, "Comparative life cycle analysis of conventional and hybrid heavy-duty trucks," *World Electric Vehicle Journal*, vol. 9, no. 2, p. 33, 2018.
- [12] C.-C. Lin, H. Peng, J. W. Grizzle, J. Liu, and M. Busdiecker, "Control system development for an advanced-technology medium-duty hybrid electric truck," *SAE transactions*, pp. 105-113, 2003.
- [13] A. Lajunen, "Fuel economy analysis of conventional and hybrid heavy vehicle combinations over real-world operating routes," *Transportation Research Part D: Transport and Environment*, vol. 31, pp. 70-84, 2014.

- [14] C. Bachmann, F. Chingcuanco, H. MacLean, and M. J. Roorda, "Life-cycle assessment of diesel-electric hybrid and conventional diesel trucks for deliveries," *Journal of Transportation Engineering*, vol. 141, no. 4, p. 05014008, 2015.
- [15] H. Zhao, A. Burke, and M. Miller, "Analysis of Class 8 truck technologies for their fuel savings and economics," *Transportation Research Part D: Transport and Environment*, vol. 23, pp. 55-63, 2013.
- [16] C. Kwasi-Effah and A. Obonor, "Modeling and simulation of a gasoline-electric vehicle," *International Journal of Engineering & Technology*, vol. 1, no. 4, pp. 163-176, 2013.
- [17] A. O. Kiyaklı and H. Solmaz, "Modeling of an electric vehicle with MATLAB/Simulink," *International journal of automotive science and technology*, vol. 2, no. 4, pp. 9-15, 2019.
- [18] B. Sharmila *et al.*, "Modelling and performance analysis of electric vehicle," *International Journal of Ambient Energy*, vol. 43, no. 1, pp. 5034-5040, 2022.
- [19] M. Waseem, M. Suhaib, and A. F. Sherwani, "Modelling and analysis of gradient effect on the dynamic performance of three-wheeled vehicle system using Simscape," *SN Applied Sciences*, vol. 1, pp. 1-13, 2019.
- [20] F. Adegbohun, A. Von Jouanne, B. Phillips, E. Agamloh, and A. Yokochi, "High performance electric vehicle powertrain modeling, simulation and validation," *Energies*, vol. 14, no. 5, p. 1493, 2021.
- [21] G. Payeganeh, M. Esfahanian, and S. P. Bonab, "Modeling and fuzzy control strategy design for the hydraulic hybrid refuse truck," *International Journal of Automotive Engineering*, vol. 4, no. 2, pp. 685-698, 2014.
- [22] S. Pakdel Bonab, A. Kazerooni, G. Payganeh, and M. Esfahanian, "Extracting Tehran refuse collection truck driving cycle and estimating the braking energy," *Int. J. Automot. Eng*, vol. 10, pp. 3149-3157, 2020.